

# ML-605M Series Electro-Mechanical Lock Installation Instruction

## Specification

- Operating Voltage: 12~24VDC/AC  $\pm 10\%$
- Current Draw: 250mA/12VDC; 150mA/24VDC
- Operating Temperature: 14°F to 120°F (-10°C~+49°C)
- Humidity: 0~85% non-condensing
- Version Changeable: Fail-safe or Fail-secure
- Lock bolt sensor switch output: SPDT, 3A/125VAC
- Latch Throw: 15mm
- Solenoid testing: Tested to 250,000 cycles
- Backset:
  - ML-605M-30: 30mm
  - ML-605M-35: 35mm

## Dimension

Unit: mm

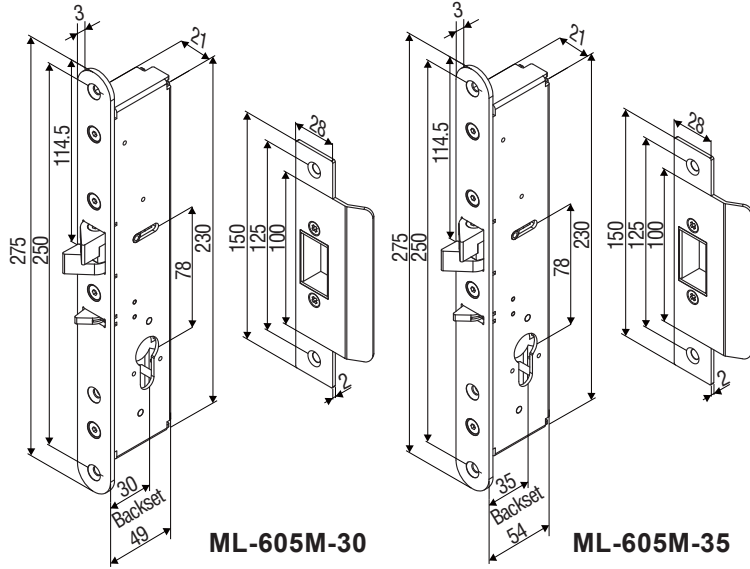

## Packing Contents

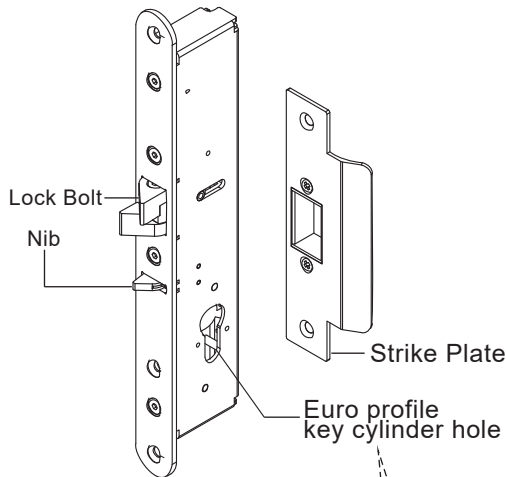

## Stud Bolt Position

For fail-safe mode

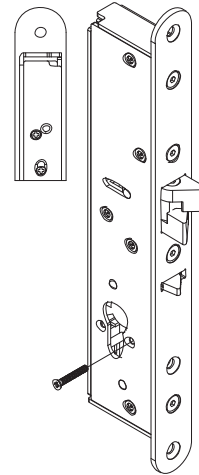

For fail-secure mode

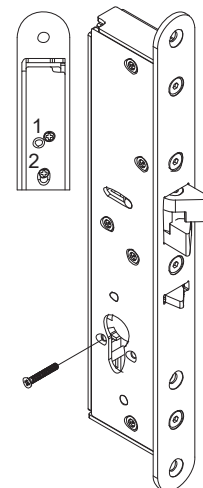

### Version Changeable:

Take out the Screw 1, release screw 2, move the position and then tighten both screws.

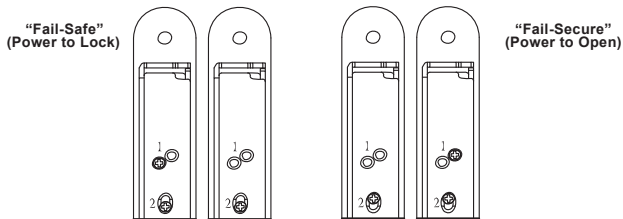

### ⚠ Caution:

Do not completely remove screw 2 (as marked in the figure) as the interior solenoid might fall off.

# Installation Instructions

62mm cylinder for max · 42mm door leaf  
 72mm cylinder for max · 52mm door leaf

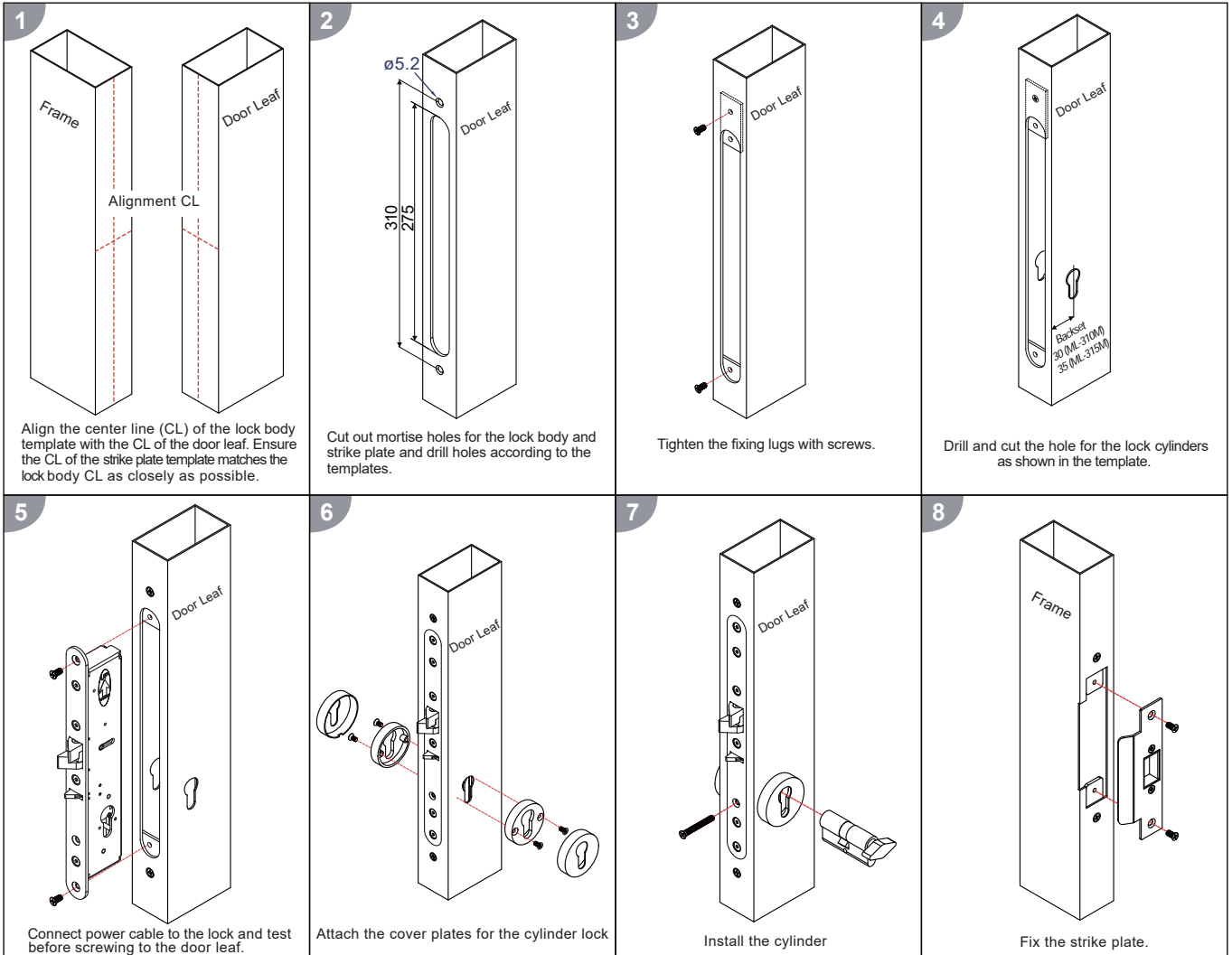
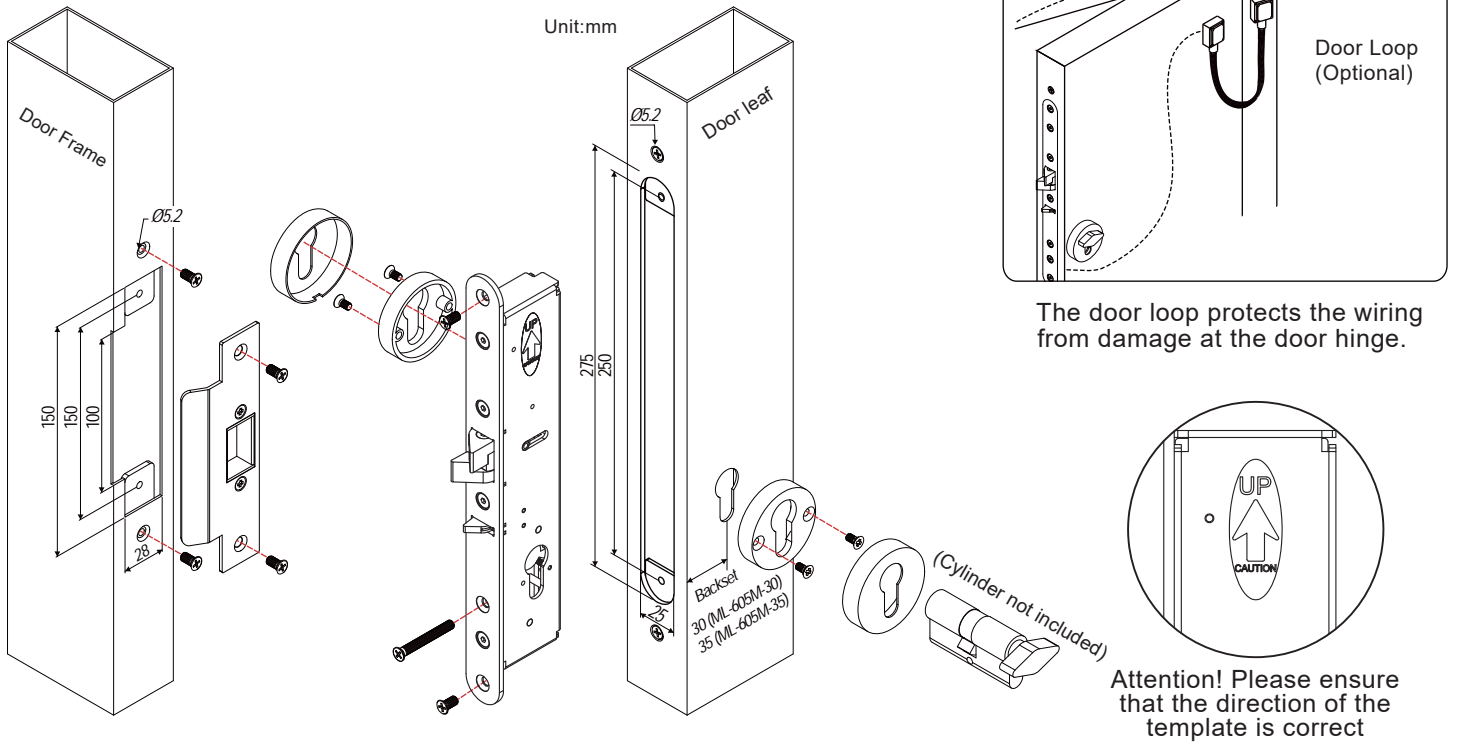

## Wiring Diagram

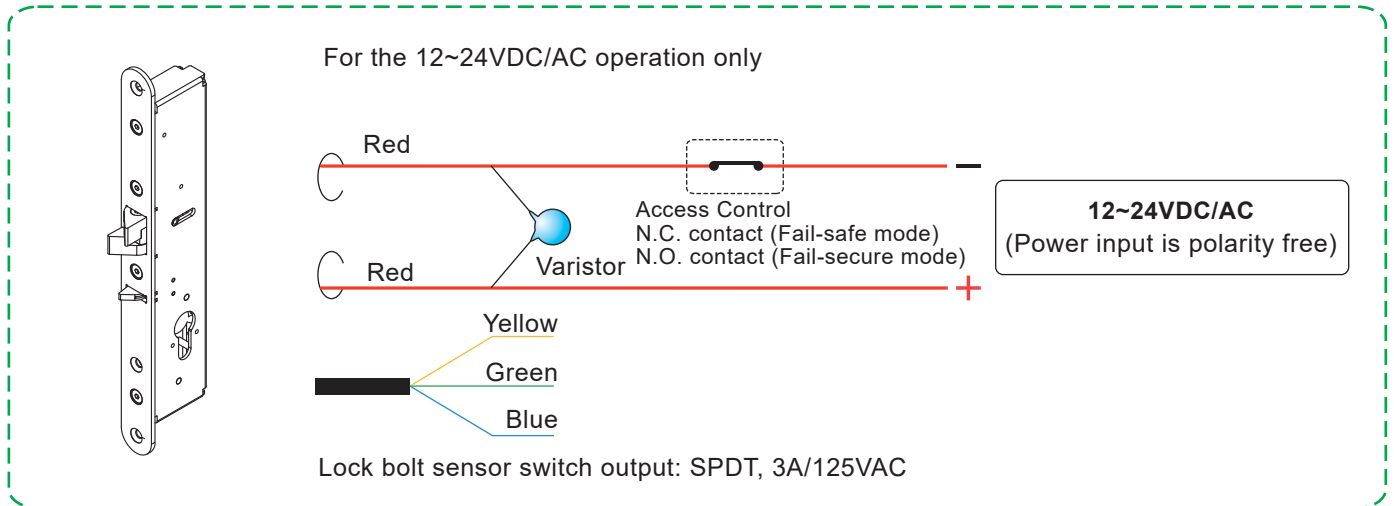

**NOTE:** The varistor (or diode) must be connected across the terminals as shown above. This protects the electromechanical lock from spikes and surges.

## Butt Splice (IDC) Connector

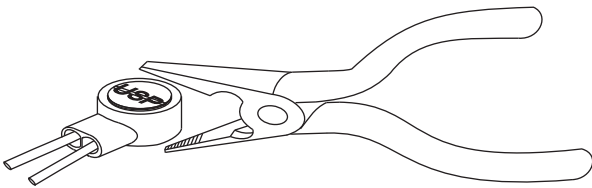

Using crimper or pliers and pressing the header of connector down to even position.