

# Dimension

## GK311

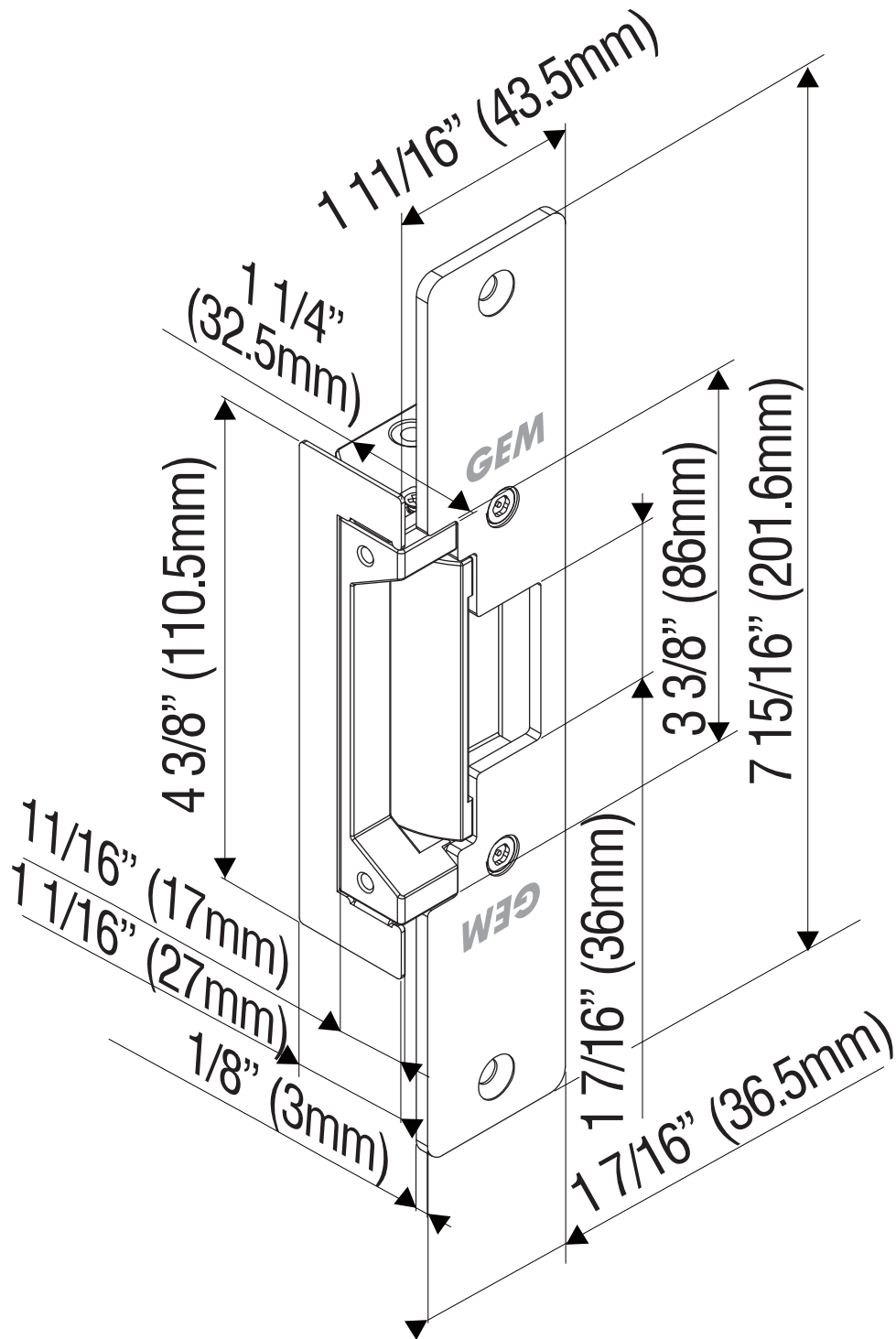

All dimensions in mm