

Installation Instruction

(1)

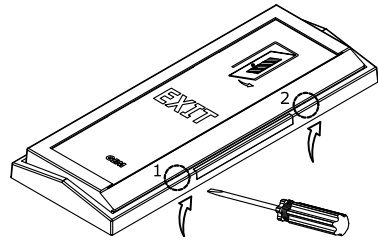

Loosen the 2 screws, using a typical slotted screwdriver

(2)

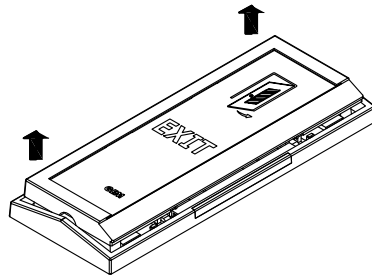

After the step 1, you can lift up the upper cover from switch

(3)

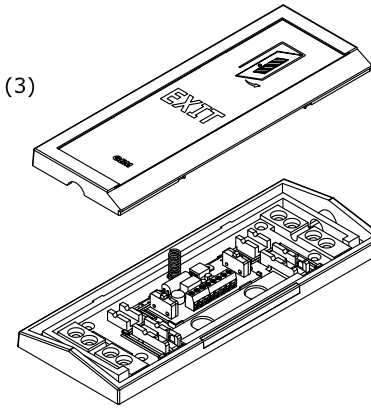

Separate the PCB Board from the base housing, you will see the holes for electrical outlet box for either Euro or ANSI Type

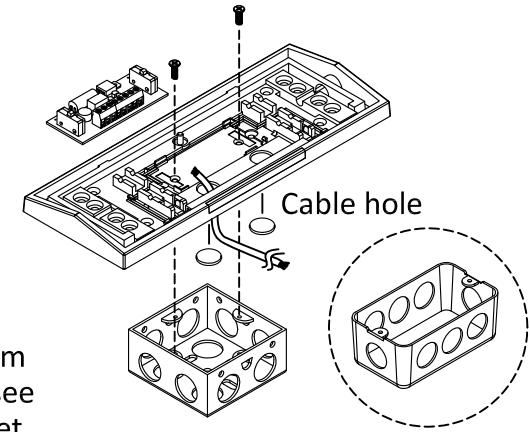

Euro type socket

ANSI socket

(4)

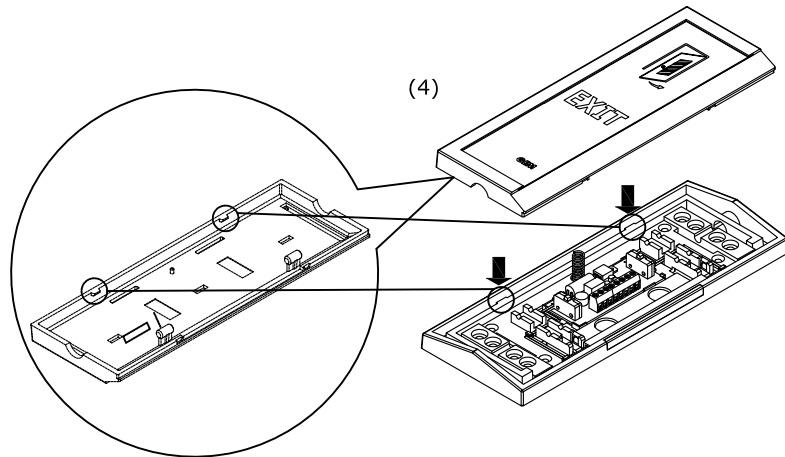

Align and attach the cover with the conducting base housing

(5)

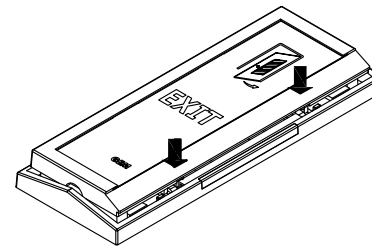

Carefully press the cover cap into place until the latches snap into place, you will hear a steady click

(6)

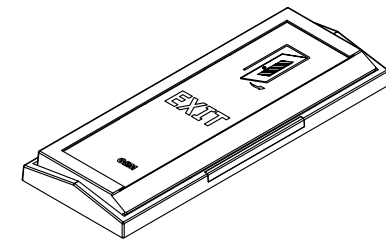

Do some test to press the switch to see whether the LED light bar is working properly or not