

EASIPROX Stand Alone Reader Operation Manual

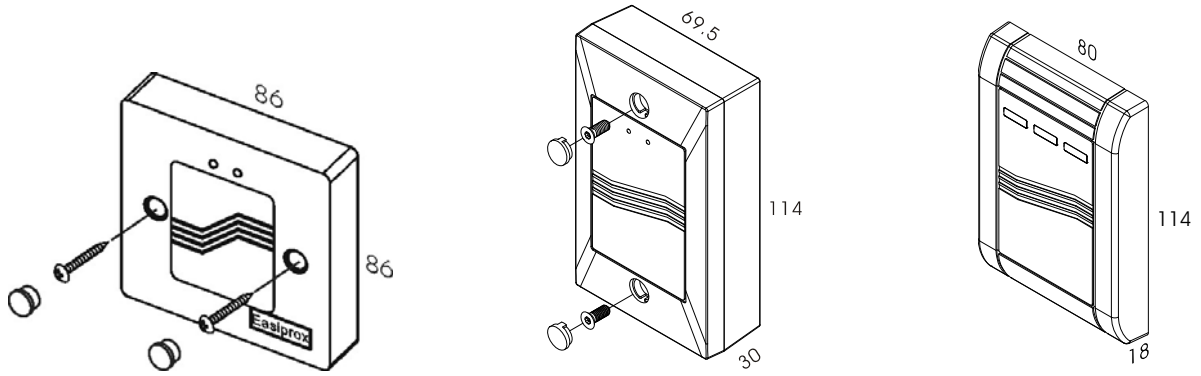

Unit: mm

EASIPROX

EASIPROX-ANSI

EASIPROX-980-40

I. Features

1. Memory volume up to 2000 proximity cards/tokens. Reading time approx. 0.5 seconds.
2. Programming via Master Card.
3. Preventing re-entering the same card.
4. Non-volatile memory stores all cards even in the event of total power failure or when the reader is not in use for a long time.
5. Epoxy sealed. Standard size of single-gang box.

II. Specification

Operating Voltage	12 VAC/VDC
Current Draw	Pull In: 70 mA/12 VDC; Holding: 45 mA/12 VDC
RF Frequency	125 KHz (ABA form code)
Read Range	10~15 cm (depending on local installation conditions)
Input	1 contact for Request-To-Exit button
Output	1 relay (Dry contacts: N.O./N.C./Com.)
LED Status Indication	2-LED indicators (Yellow & Green / Red); 3-LED indicators (Yellow, Green, Red)
Memory Volume	2000 proximity cards/tokens
Format	EM-400x 64-bit Standard R/O or Compatible
Relay Rating	Max. 5A/250 VAC
Relay Strike Time	0.7 ~ 42 seconds
Ambient Humidity	5%~95% (Non-condensing)
Operating Temperature	-20°C~70°C
EMC Specification	Meet CE requirement

III. LED Status Indication

Mode	Signal	Status
Standby	Yellow & Green LED flash	No Master Card (empty memory)
	Yellow LED On	Standby
	Green LED On	Relay strike time
	Red LED On	Invalid card
Programming	Green LED flash	Add cards
	Red LED flash	Delete cards
	Yellow & Red LED flash	Clear memory
	Yellow LED flash	Adjustment of relock time (1 ~ 60 flashes, 0.7 ~ 42 seconds)
	Green LED flash	Clear all memory (including Master Card)

IV. Wiring Diagram

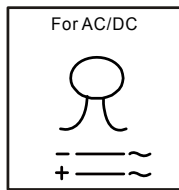
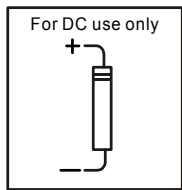
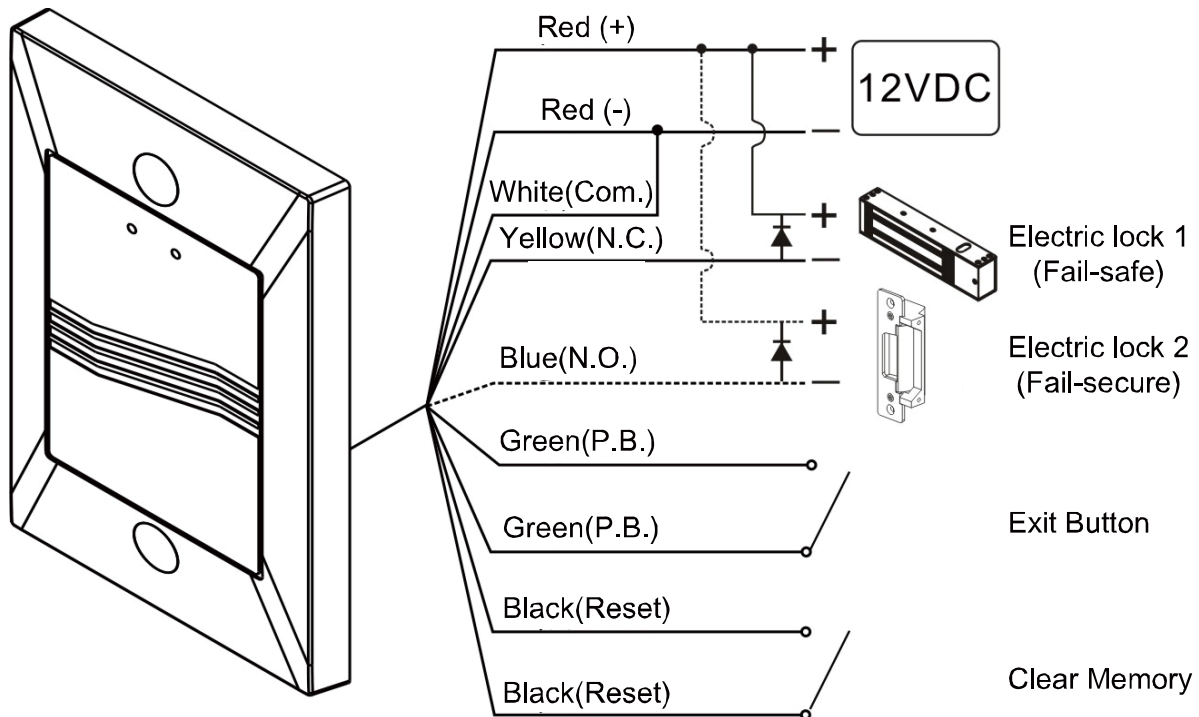

Red	12 VDC (polarity free)	Green	Exit Button
Red	12 VDC (polarity free)	Green	Exit Button
White	Com.	Black	Clear all memory
Yellow	N.C.	Black	Clear all memory
Blue	N.O.		

Note:

1. It is suggested to use #22~26 AWG insulation wire.
2. It is suggested to use a linear power supply unit to prevent the reduction of reading range.
3. The door strike or relay must have a varistor or a diode across the door strike terminals to suppress the back EMF of the strike. Failure to do so will damage the relay contacts and electronic components, or even burn the controller.
4. Exit button is at N.O. contact.

V. Operation Instruction

1. Set Master Card

Yellow and Green LED flash indicates that the memory is empty. The first card read by the reader will be the Master Card.

Read the Master Card (Yellow LED stay on), enter standby mode

Note: The same Master Card can be used on more than one reader.

2. Add new cards

1. Read Master Card once (Green LED stay on for 3 seconds, then flash), enter adding card mode

2. Read the new card(s) (relay active → successfully adding the new card)

3. Read Master Card once (Green LED off, Yellow LED stay on), back to standby mode

Note: It is suggested to use the card of ABA form codes and make a list of the cards added to the reader.

3. Delete cards

1. Read Master Card twice within 2 seconds (Red LED stay on for 3 seconds and flash), enter deleting card mode

2. Read the card(s) (Green LED stay on → successfully delete cards)

3. Read Master Card once (Red LED off, Yellow LED stay on), back to standby mode

4. Clear all memory

1. Read Master Card 3 times, each time within 2 seconds of interval (Yellow & Red LED stay on for 3 seconds and flash), enter clearing memory mode
2. Read any EM-400x 64-bit R/O compatible card except Master Card (Green LED flash → in the process of clearing all memory, including Master Card)
3. Empty memory and back to default value (Yellow & Green LED flash)
4. Follow step 1 to set new Master Card

If the Master Card is lost, follow the steps below to clear all memory:



1. Turn off the power
2. Connect the two black cables and turn on the power
3. In the process of clearing all memory, including Master Card (Green LED flash)
4. Disconnect the two black cables (Yellow & Green LED flash → memory is empty)

5. Set relock time

1. Read Master Card 4 times, each time within 2 seconds of interval (Yellow LED stay on for 3 seconds, then flash), enter relock time setting mode
 2. Each flash indicates 0.7 seconds. If the relock time is set to 5 seconds, after 7 flashes, read the Master Card once. (Yellow LED stay on), back to standby mode
- Note: The longest relock time is 42 seconds (60 flashes). After 60 flashes, the Yellow LED will automatically stay on and go back to standby mode.

VI. TS-980 Tag Simulator (optional)

TS-980 Tag Simulator simulates any card/tag number stored in the memory of the reader. When you plan to delete a lost card/tag from the memory, Tag Simulator is used to transmit the number of the lost card/tag to the reader and then you can begin to delete it from the memory.

For example: delete the card, ABA code 0001206932. Press **On/Off** continuously. When the screen displays 0001262368, press  → 0001262368, and press  → 0001202368.

Repeat the preceding step. When the screen displays 0001206932, and the reader enters deleting card mode, press **Send** (The distance between the Tag Simulator and the reader must be within 3 cm.) Card deletion is completed.

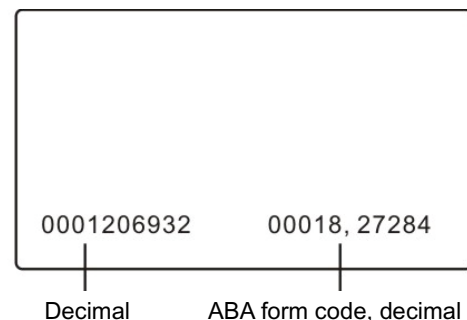
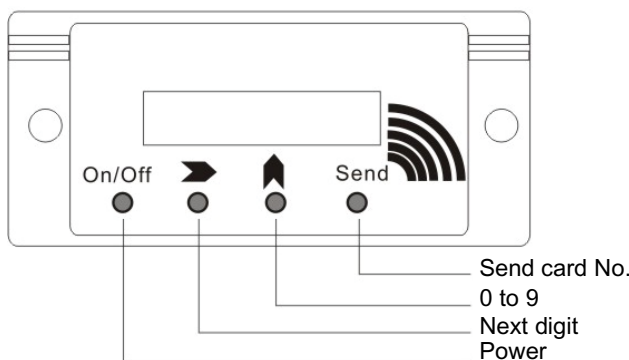

Warranty

The product is warranted against defects in material and workmanship while used in normal service for a period of 1 year from the date of sale to the original customer. The GEM policy is one of continual development and improvement; therefore GEM reserves the right to change specifications without notice.

