

Application for the Electromagnet:
GL-1200 series

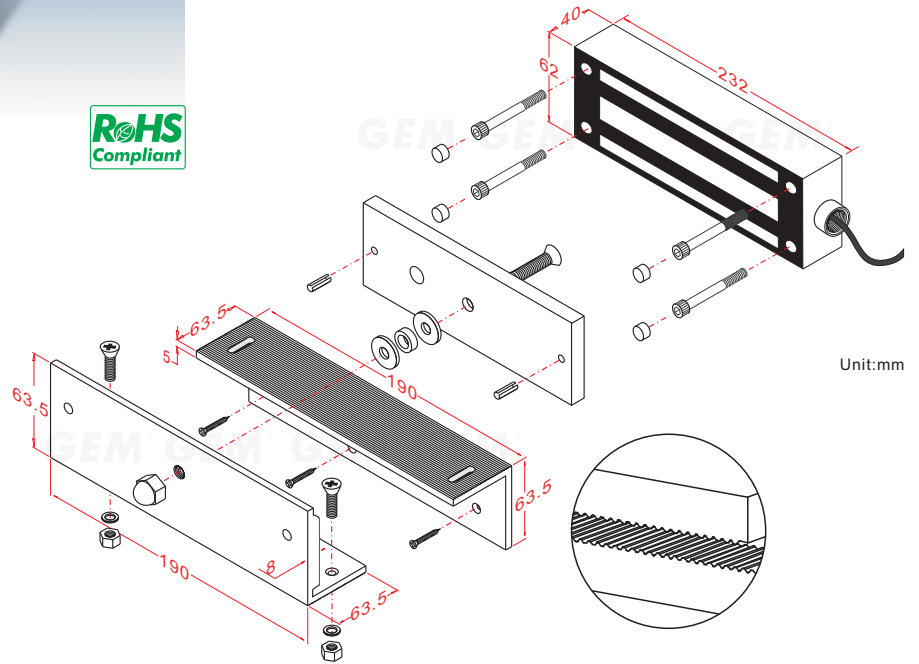

Unit:mm

Installation Steps of "Z" bracket for In-swinging doors

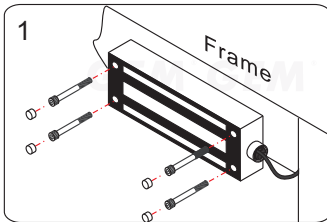

1 Tighten the electromagnetic lock on the L bracket by using the fixing screw.

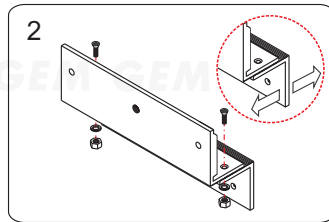

2 Assemble the Z bracket, and make sure that the Z bracket is adjustable.

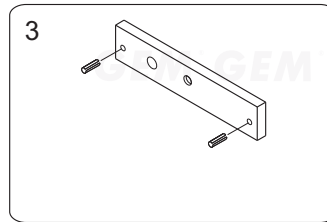

3 Insert the guide pins into the armature plate.

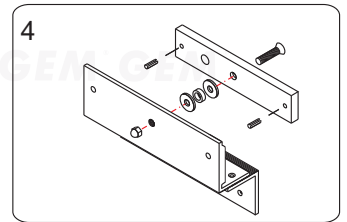

4 Put one rubber washer between armature plate and the Z bracket.

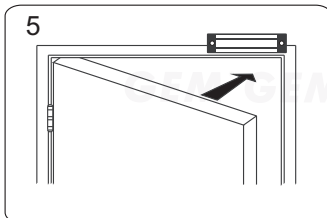

5 Close the door. Measure the correct position by bringing the armature plate close to the contact surface of the electromagnetic lock.

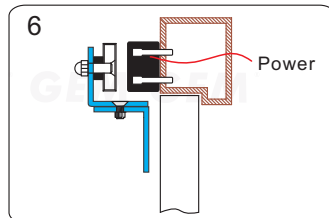

6 Turn on the power of EM-Lock, and let the armature plate bonds to the EM-lock. Adjust the position between the Z bracket and the door frame.

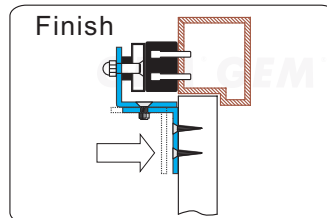

Finish
Once the position is correct, use the screws to permanently mount the Z bracket on the door frame. This should be the last step.

GIANNI INDUSTRIES, INC.

No.306-1, Hsin Shu Road, Hsin Chuang, Taipei, Taiwan 242
TEL: 886-2-2206 9929 FAX: 886-2-2204 6632
E-Mail: info@gianni.com.tw
Website: gianni.tw



The products are manufactured under an ISO 9001 & QC 080000 Certified Quality Management Program environment back its product quality, performance and commitment to customer satisfaction.