

■ Application for the Electromagnet: GL-850

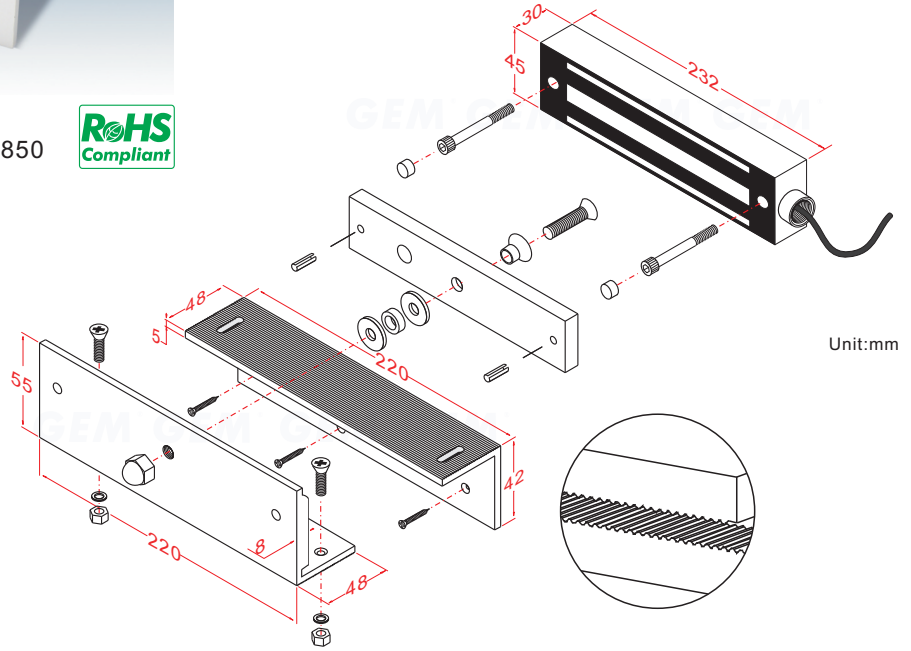

### Installation Steps of Z bracket for Inswing doors

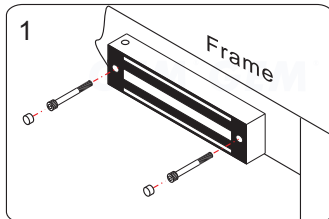

1 Tighten the electromagnetic lock on the L bracket by using the fixing screw.

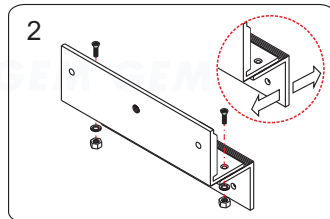

2 Assemble the Z bracket, and make sure that the Z bracket is adjustable.

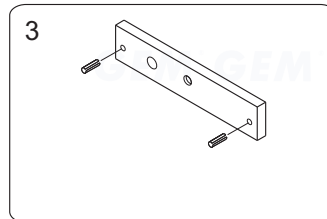

3 Insert the guide pins into the armature plate.

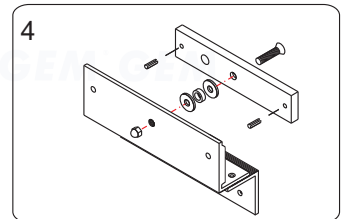

4 Put one rubber washer between armature plate and the Z bracket.

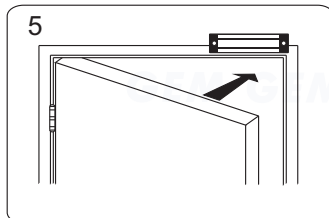

5 Close the door. Measure the correct position by bringing the armature plate close to the contact surface of the electromagnetic lock.

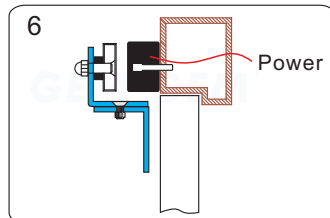

6 Turn on the power of EM-Lock, and let the armature plate bonds to the EM-lock. Adjust the position between the Z bracket and the door frame.

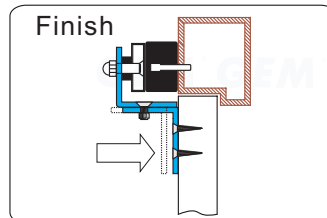

Finish Once the position is correct, use the screws to permanently mount the Z bracket on the door frame. This should be the last step.

**GIANNI INDUSTRIES, INC.**