

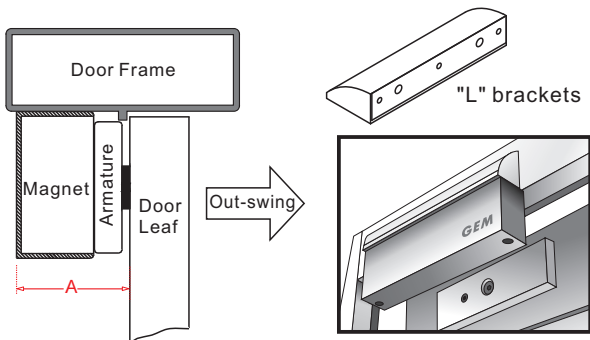

Application for the Electromagnet: GL600-S

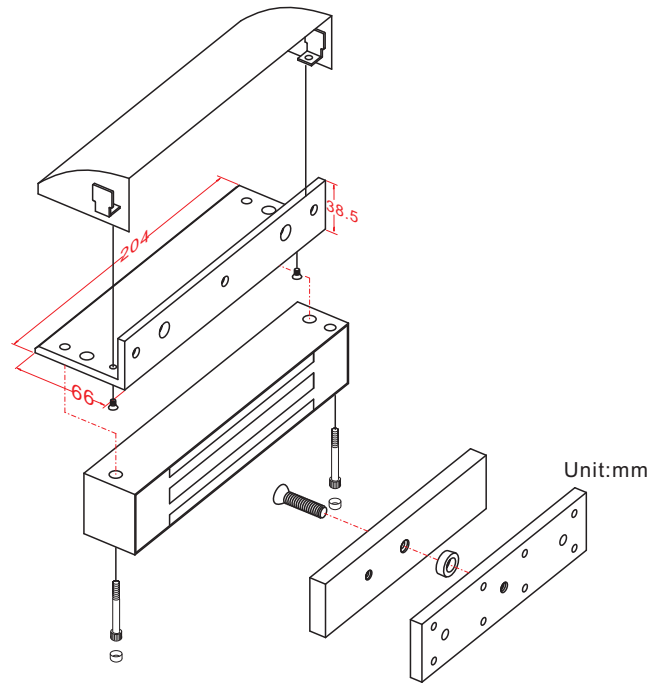

**L-bracket for narrow door frames**  
When "A" < 60 mm, must installed with "L" brackets.

### Installation of L bracket on Outswing Doors

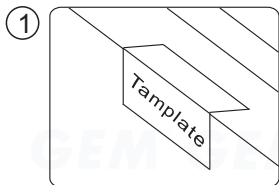

1 Fold the mounting template 90° angle along the dotted line.

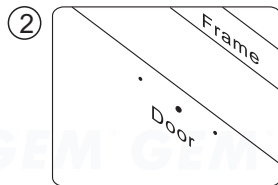

2 Drill the holes marked on the template.

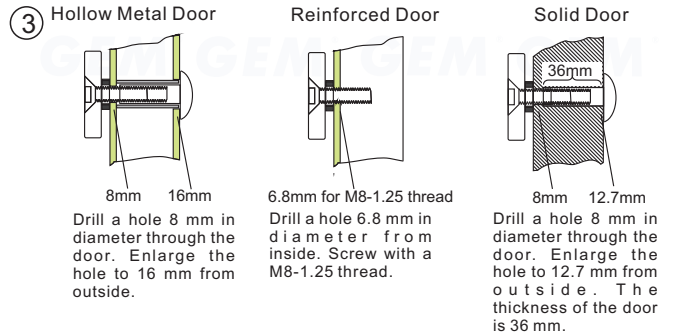

3 Hollow Metal Door  
Drill a hole 8 mm in diameter through the door. Enlarge the hole to 16 mm from outside.

Reinforced Door  
Drill a hole 6.8 mm in diameter from inside. Screw with a M8-1.25 thread.

Solid Door  
Drill a hole 8 mm in diameter through the door. Enlarge the hole to 12.7 mm from outside. The thickness of the door is 36 mm.

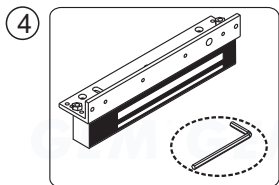

4 Assemble the electromagnet and L bracket with an Allen wrench.

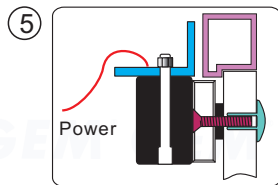

5 Turn on the power of electromagnet. Let the electromagnet and the armature plate bond together. Press L bracket against the door frame.

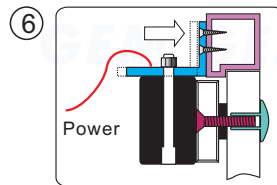

6 Fasten L bracket on the door frame.

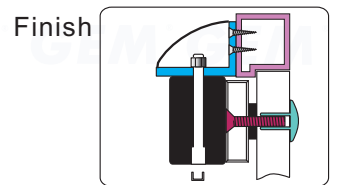

Finish  
Test the unit. Tap the plugs into the electromagnet