



● Statement

The EB262 electric dropbolt has a logic circuitry. The positioning ball above the dropbolt keeps the bolt retracted while the door is not locked on strike plate until the door closed properly. This design is for security purpose, which solves the problem of improper door positioning.

● Specification

- Fail-Safe Version (Power to Lock)
- Power Input: 12 VDC
- Voltage Tolerance: ±10%
- Current Draw: Pull in: 0.9A, Holding: 0.3A/12VDC (at 20°C)
- Magnetic bolt status output (SPDT rated 3A/30VDC) indicates bolt is in a locked or unlocked status.
- Operating Temperature: -10~+45°C
- Humidity: 0~95% non-condensing.
- Tested over 500000 cycles.
- Built-in logical circuitry
- Auto-relocking Time Delay : 0, 3, 6, 9 seconds
- Faceplate Material: stainless steel
- Net Weight: 1.2 Kg

● Double Action Doors

EB262 Electric dropbolt is specially designed for use on double swing doors. They can also be installed on both outswing and inswing doors.

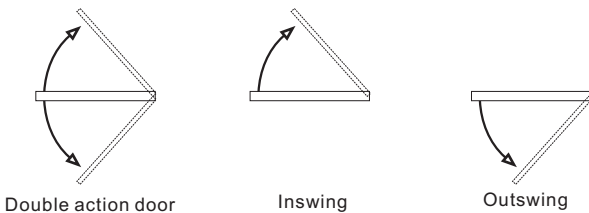

● Dimensions

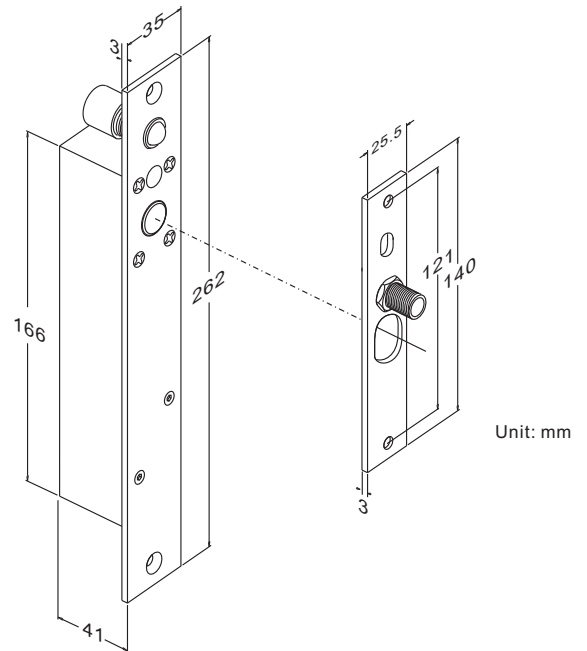

● Vandal Resistant

The vandal resistant circuitry means the door position sensor can't be fooled into projecting the electric dropbolt unless the door is actually closed. The reed sensor automatically disconnects after the bolt is projected to enhance security of the lock.

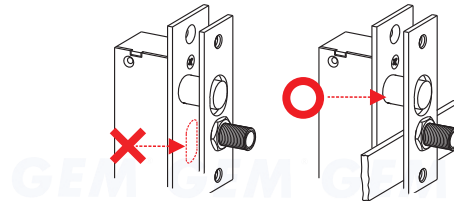

● Auto-detective circuitry

The unique intelligent logic circuit in GEM's electric dropbolts keeps the bolt retracted until the door is properly closed. This feature ensures the bolt will not extend if the door is improperly aligned.

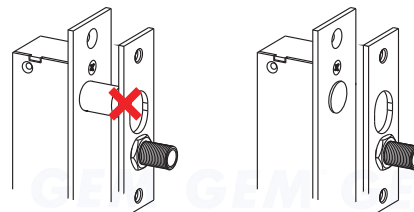

GIANNI INDUSTRIES, INC.

● Horizontal or vertical installation

GEM's electric dropbolts can be installed either horizontally at the top or bottom of the door frame or vertically on the side of the door frame.

Fig. A Horizontal Installation (Frame Header)

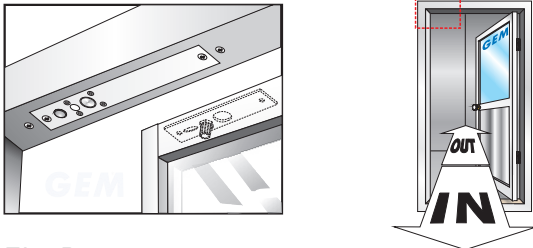
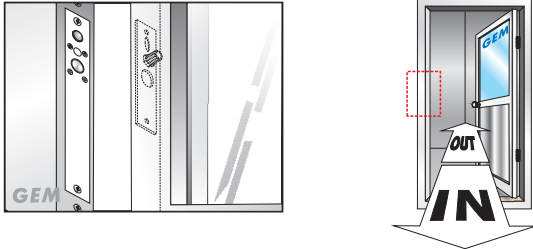
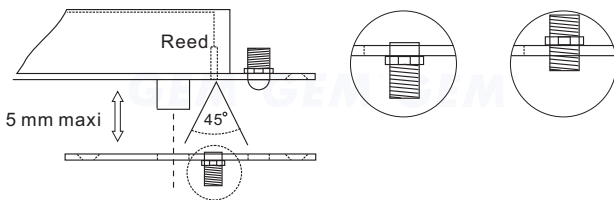

Fig. B Vertical Installation (Side Jamb)



● Adjustable Sensor

The door position sensor can detect within a range of 5mm. If the door gap is too wide, a magnet within the strike plate of the door can be adjusted to improve detection accuracy.



● Positioning Ball

Positioning Ball is installed to prevent the chance of locking damage caused by the improper door positioning. It also helps the door align with the drop bolt and reduce the automatic relock time of dropbolt when the door is closed.

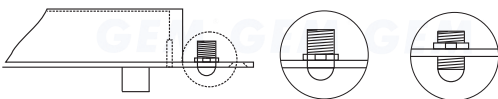

● Relock Time Delay

Adjustable Time Delay of 0,3,6,9 seconds with 2 way DIP switch. (Default Value: 0 sec.)

Relock time setting

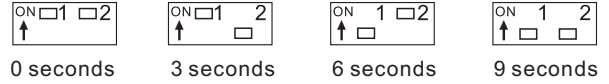

● Long life solenoids

The special designed solenoid aims for strength and long life. The solenoid is guaranteed 500,000 times of operations.

● Energy Saving Design

After the dropbolt is completely locked, the current draw changes from 0.9A to 0.3A to prolong its life.

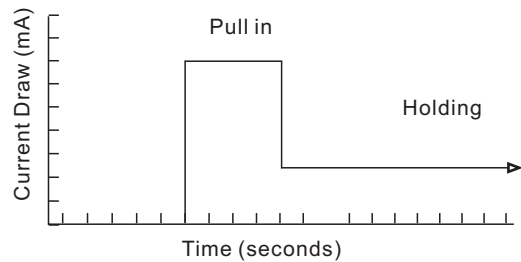

● Optional Accessory

The brackets UBK-262 are compatible with frameless glass doors (Fig. C).

UBK-262 Bracket
For 10 or 12 mm thickness of glass

Fig. C

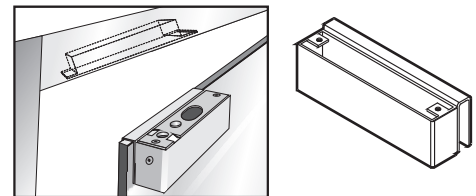

● Warranty

The product is warranted against defects in material and workmanship while used in normal service for a period of 1 year from the date of sale to the original customer. The GEM policy is one of continual development and improvement; therefore GEM reserves the right to change specifications without notice.

GIANNI INDUSTRIES, INC.