



● Features

- High reliability
- Aluminum anodized casing
- MOV provides spike and surge protection
- Dual voltage 12 or 24 VDC (selectable)
(10002BZ:12VDC)
- Anti-Residual magnetism function

● Statement

10001 series are designed for surface mount on out-swing doors. The maglocks can be configured to mount on in-swing and glass doors with optional LZ- and U-shaped brackets. Other optional operation features include magnetic bond sensor, relock time delay, door status monitor, and buzzer alarm.

● Specification

- Operating voltage: 12/24 VDC
- Current draw: 500mA/12VDC; 250mA/24VDC (at temperature 20°C)
- Operating temperature: -10~55°C(14~131°F)
- Humidity: 0~95% non-condensing.
- Holding force: Up to 600 lbs(272 Kg)
- Dimensions:
 - Magnet:(L) 250, (W) 42, (D) 26 mm
 - Armature plate:(L) 185, (W) 38, (D) 12 mm
 - Mounting plate:(L) 250, (W) 25, (D) 5 mm
- Special finishes for magnet and armature plate: Zinc plated
- Epoxy potting compound : E87252 (S), UL94V-0
- Net Weight: 2.0 Kg

*10002BZ: (L)288,(W)42,(D)26mm

● Regular Installation

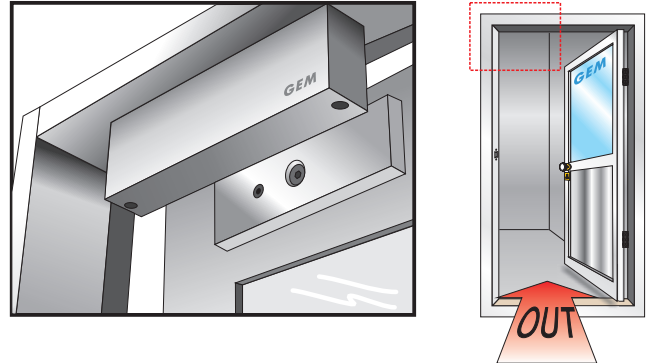

● Anti-residual statement

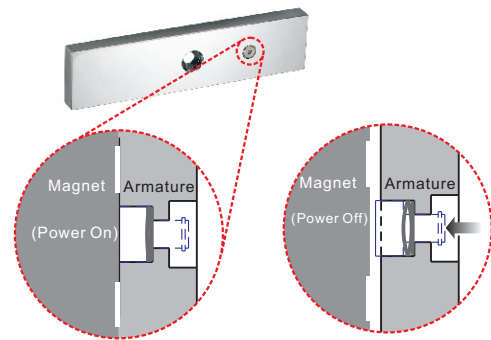

Anti-residual statement

Our electromagnet locks feature Anti-Residual Magnetism (ARM) which ensures the door can be opened without any resistance from left over magnetism imparted to the armature plate

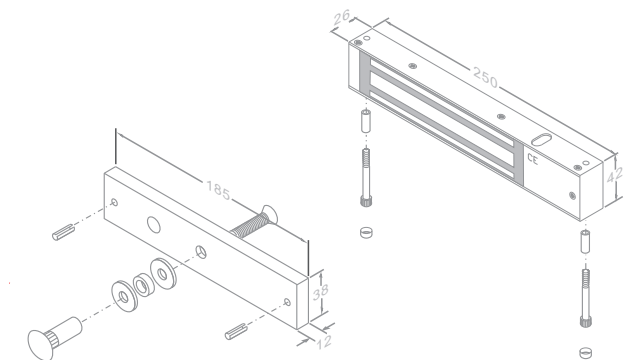

Unit:mm

GIANNI INDUSTRIES, INC.

Operating Features



10002: Bond sensor output

Indicate the locked & unlocked status with visible LED indicator.

Bond sensor output : SPDT rated: 0.5A/125VAC;1A/24VDC



10002BZ: Buzzer Alarm

Door Held Open Alarm is an auditory feedback for users. The alarm sounds when the door is not closed and that has exceeded a specified time limit. VR timer is adjustable from 1 to 20 seconds.

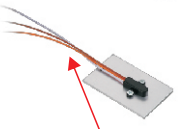

10002DS: Door status

Door Status Sensor indicates the door is in an open or closed status.

Door status output : SPDT rated: 0.2A/12VDC



10002TD: Relock time delay

Ensure automatic locking after the door is closed properly. Relock time delay can be adjusted from 1 to 80 seconds.



Optional Brackets

Bracket installation is according to door swing direction and door frame type , e.g. narrow frame door , frameless glass door , inswing door , etc.

U-bracket for frameless glass doors
UBK-013 for 10~12mm glass thickness

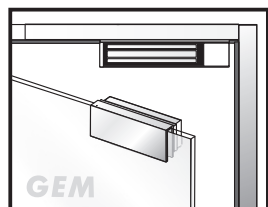
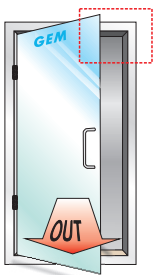

L-bracket for narrow door frames

When "A" < 42 mm , must installed with "L" brackets.

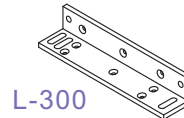
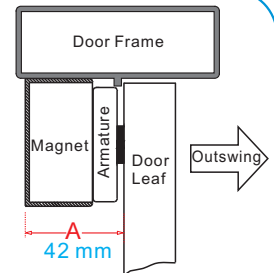

L-300

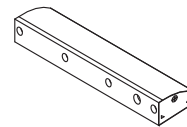
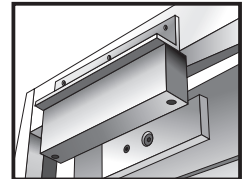

EM-10001L

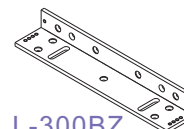
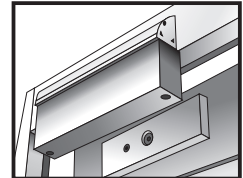

L-300BZ
(For 10002BZ)

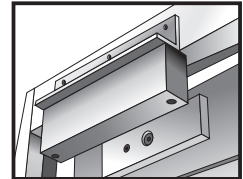

LZ-bracket for in-swing doors

LZ-300N

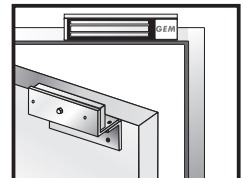
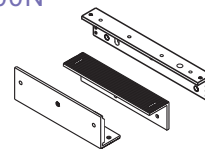

EM-10001LZ

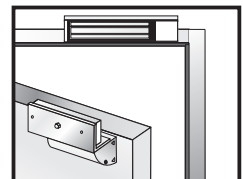
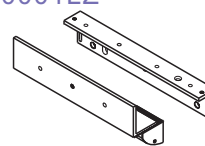

LZ-300BZ (For 10002BZ)

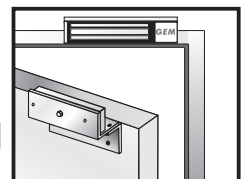
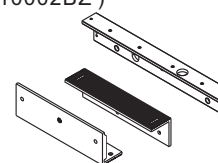

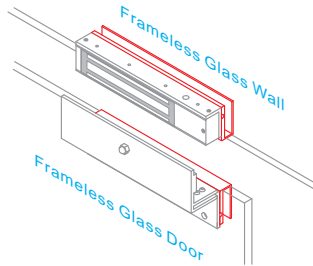

UBK-300-2 and UBK-300-3 brackets are compatible with LZ-300 brackets for 10001 series of electromagnetic locks. These brackets allow for installation on 10 ~ 13 mm thickness of in-swing glass doors and frames. (Except 10002BZ)

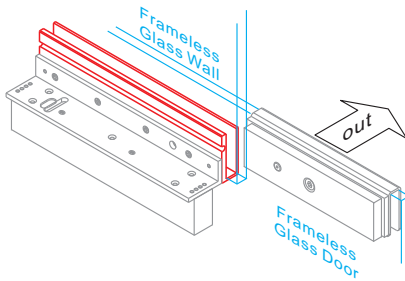
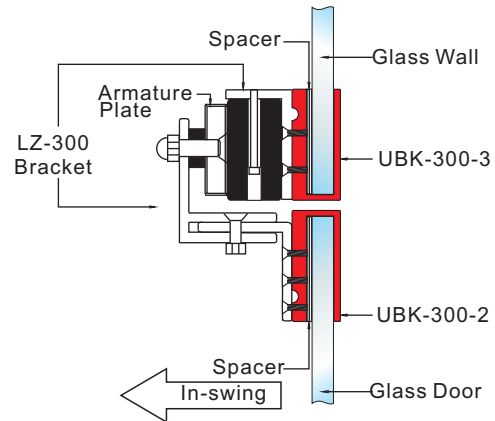

UBK-300-1 bracket is compatible with L-300 and UBK-013 for 10001 series of electromagnetic locks. The bracket allows for installation on 10 ~ 13 mm thickness of out-swing glass doors and frames. (Except 10002BZ)

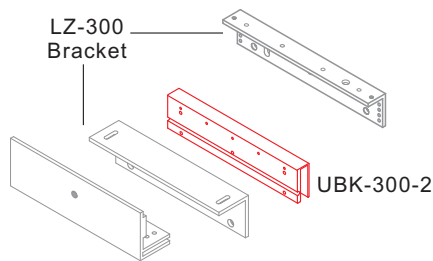
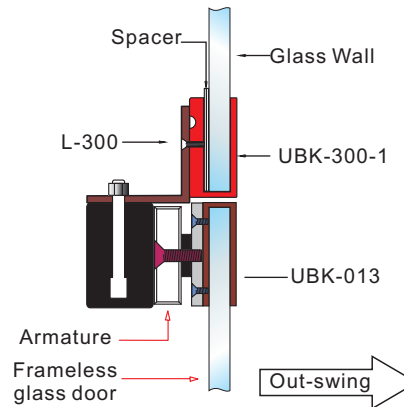

UBK-300-2 brackets are compatible with LZ-300 brackets for 10001 series of electromagnetic locks. These brackets allow for installation on 10 ~ 13 mm thickness of in-swing glass doors. (Except 10002BZ)

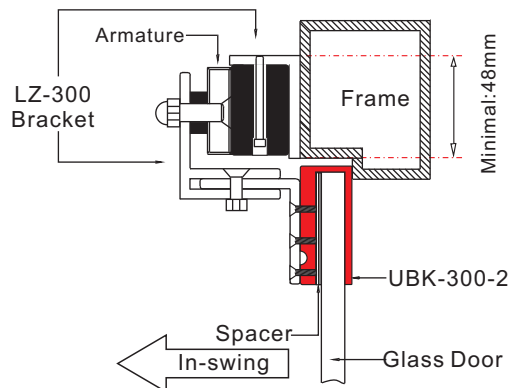

Warranty

The product is warranted against defects in material and workmanship while used in normal service for a period of 5 years from the date of sale to the original client. The GEM policy is one of continual development and improvement; therefore GEM reserves the right to change specifications without notice.

GIANNI INDUSTRIES, INC.